

Travelpro[®]
USA

PLATINUM II[™]

Parts Catalog 2001

PLATINUM II
Parts Catalog



Table of Contents

Handle Systems 3

- Two Stage Retractable Handle 3
- Three Stage Retractable Handle 3
- Top Carry Handle 5
- Side Carry Handle 5

Component Parts 6

- Wally Clamp 6
- Tower Bar Hook 6
- Attachment Clip Assembly 6
- Woven Label 6
- Bumper Feet 7
- Curved Skid Plate 8
- Skid Bar 8
- Wheel Housing Assemblies 9
- Speed Buckles 10
- Attachment Buckles 10

Hardware 11

- Zipper Sliders and Pulls 11
- Metal Logo Plate Assembly 12
- Hanger Brace 12
- D-Ring 12
- Snap Stud & Snap Cap 13
- Attachment Ring 13
- Attachment Clip Ring 13
- Dog Leash Clips 13
- Screws, Washers & Nuts 14

Accessories 15

- Wet Pockets 15
- Shoulder Strap 15
- Adjustable Attachment Clip 16
- Leather ID Tag Holder 17
- Combination Lock 17
- Door Hanger Hook 17
- Door Hook with Dog Leash Clip 17
- Suit Folders 18

Repair Kits 19

Price List 20

PLATINUM II™ Parts Catalog



Handle Systems

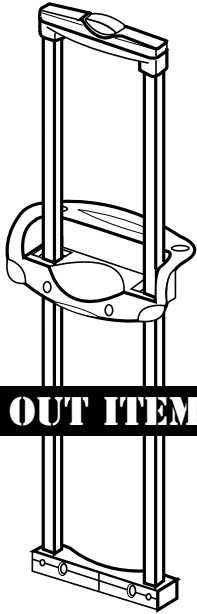

PHASE OUT ITEM

Description: Two Stage Retractable Handle
Usage: Rollaboards, Rolling Duffel
Part Numbers: P9002 22" Rollaboard
P9003 24" Rollaboard
P9004 26" Rollaboard
P9005 29" Rollaboard
P9008 Rolling Duffel

Color Codes: -14 = Sage

Description: Three Stage Retractable Handle
Usage: Rollaboards
Part Numbers: P9000 18" Rollaboard
P9001 20" Rollaboard
P9006 21" Rollaboard

Color Codes: -14 = Sage

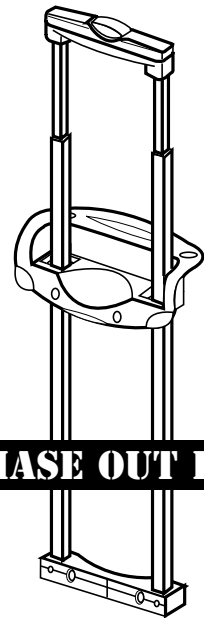

PHASE OUT ITEM

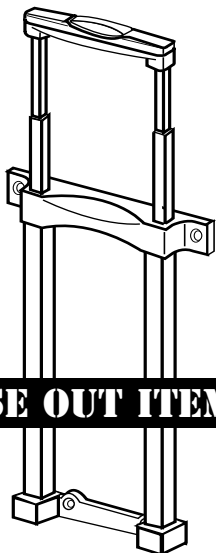

PHASE OUT ITEM

Description: Three Stage Retractable Handle
Usage: Rolling Garment Bag
Part Numbers: P9007 Rolling Garment Bag

Color Codes: -14 = Sage

PLATINUM II™
Parts Catalog



Handle Systems

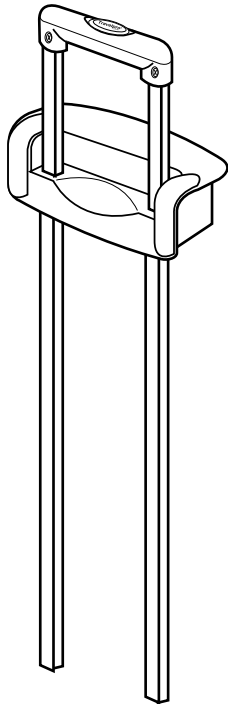

Description: Two Stage Retractable Handle with TPR Grip
Usage: Rollboards, Rolling Duffel
Part Numbers: P9002A 22" Rollboard
P9003A 24" Rollboard
P9004A 26" Rollboard
P9005A 29" Rollboard

Color Codes: -05 = Charcoal

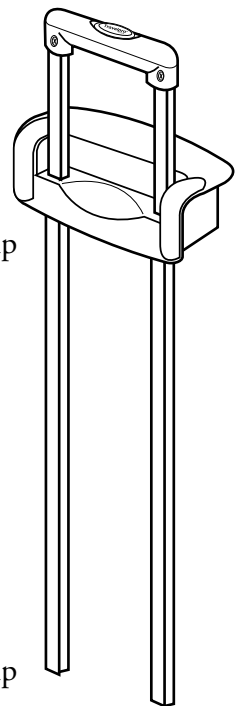

Description: Three Stage Retractable Handle with TPR Grip
Usage: Rollboards
Part Numbers: P9000A 18" Rollboard
P9001A 20" Rollboard

Color Codes: -05 = Charcoal

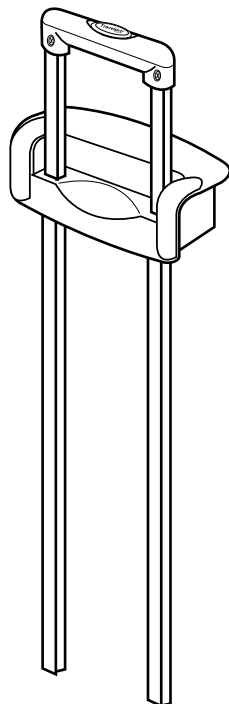

Description: Three Stage Retractable Handle with TPR Grip
Usage: Rolling Garment Bag/Wardrobe
Part Numbers: P9007A Rolling Garment Bag
P9009A Wardrobe

Color Codes: -05 = Charcoal

Description: Inner Bezel
Usage: Rollboards with TPR Handles
Part Numbers: P9090

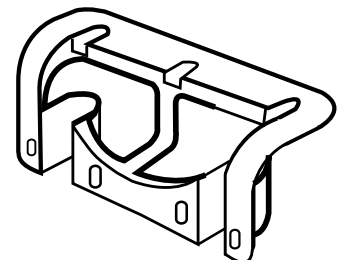

PLATINUM II™
Parts Catalog



Handle Systems

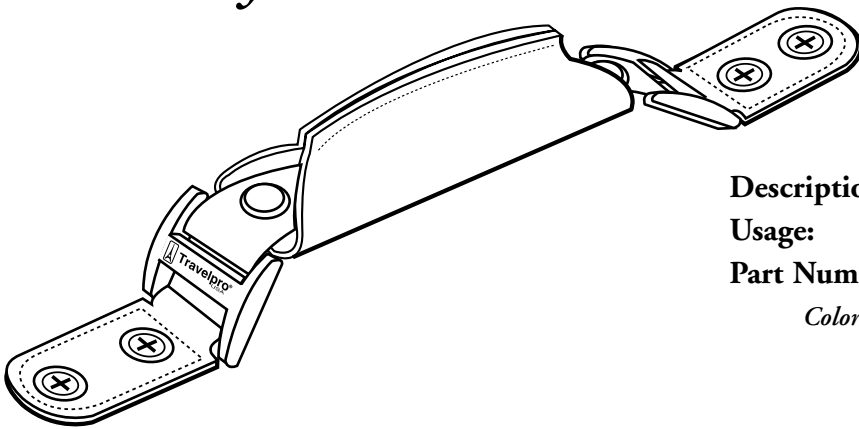

Description: Top Carry Handle w/ Logo

Usage: All Rolling Items

Part Numbers: P9010A

Color Codes: -05 = Charcoal
-14 = Sage

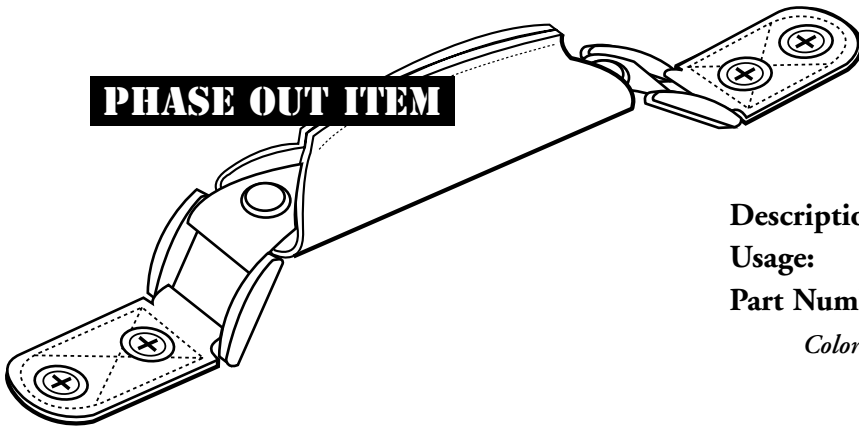

Description: Top Carry Handle

Usage: All Rolling Items

Part Numbers: P9010

Color Codes: -14 = Sage

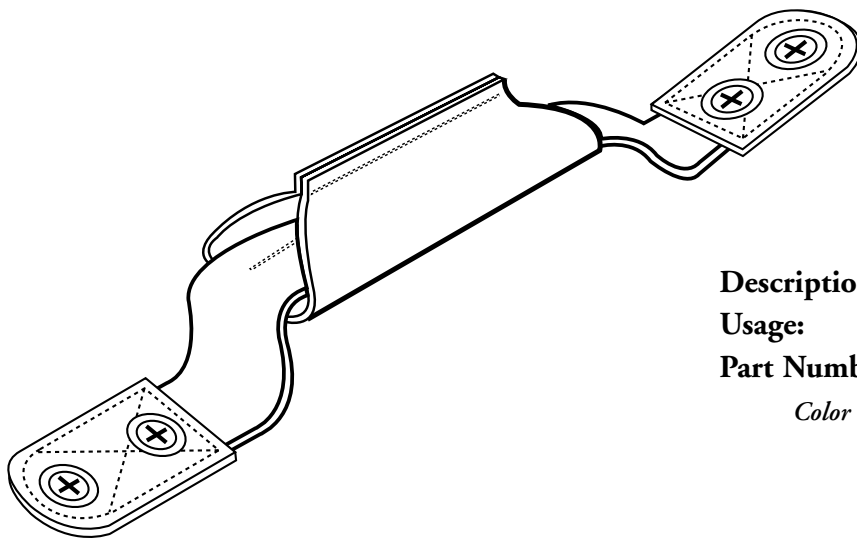

Description: Side Carry Handle

Usage: Rollaboards

Part Numbers: P9011

Color Codes: -05 = Charcoal
-14 = Sage

PLATINUM II™
Parts Catalog



Component Parts

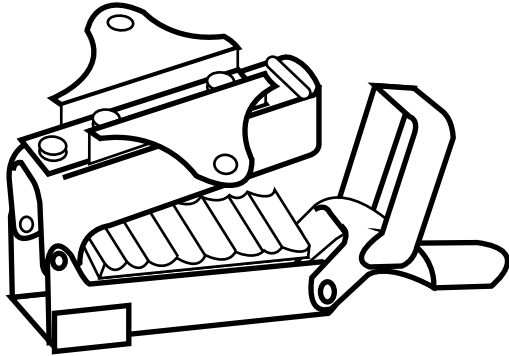

Description: Wally Clamp, 2"
Usage: Garment Bags
Part Numbers: P7941

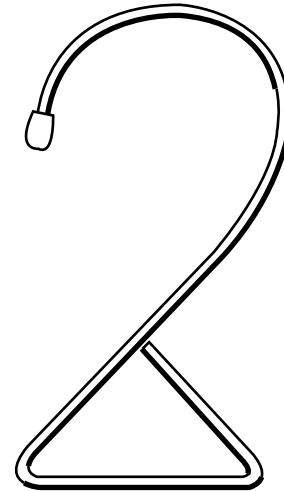

Description: Tower Bar Hook
Usage: Deluxe Toiletry Kit
Part Numbers: P9800

Color Codes: -14 = Satin Silver Plating

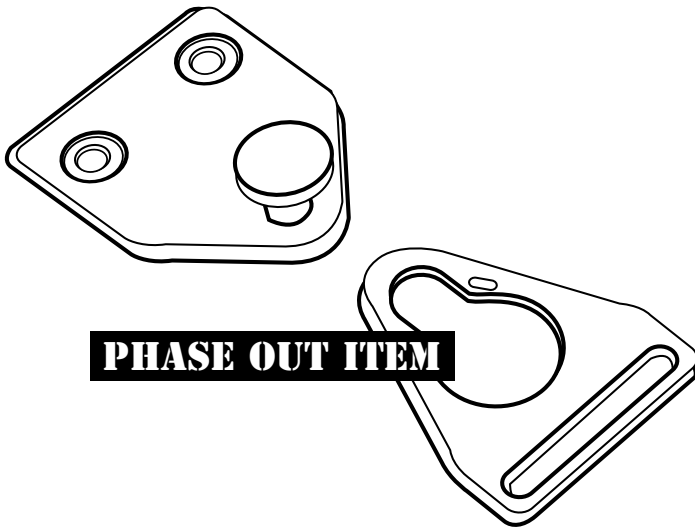

Description: Attachment Clip Assembly
Usage: All Rolling Items
Part Numbers: P9035

Color Codes: -14 = Sage

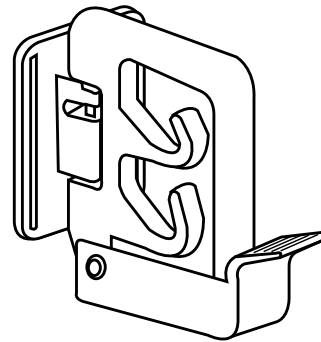

Description: Hinged Wally Clamp
Usage: Rollaboard Suiters
Part Numbers: P9041A

Color Codes: -05 = Charcoal

PLATINUM II™
Parts Catalog



Component Parts

PHASE OUT ITEM

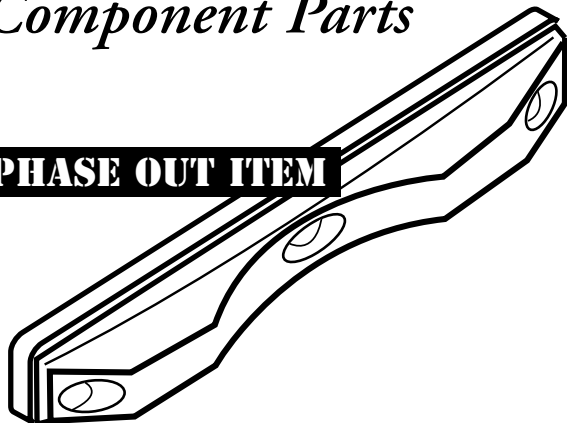

Description: Bumper Foot Bar
Usage: Rollaboards, Rolling Garment Bag
Part Numbers: P9084
Color Codes: -14 = Sage

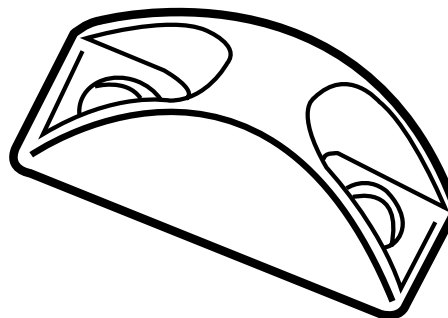

Description: Bumper Foot
Usage: Rolling Duffel
Part Numbers: P9086

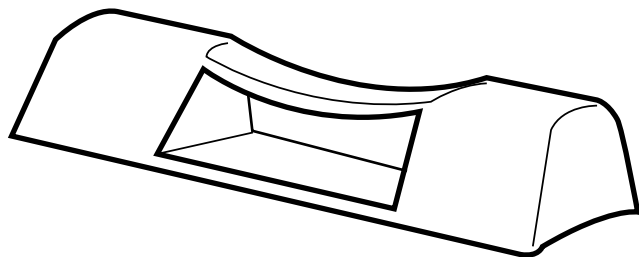

Description: Bumper Foot Bar
Usage: Rollaboards, Rolling Garment Bag
Part Numbers: P9084A
Color Codes: -05 = Charcoal
-14 = Sage

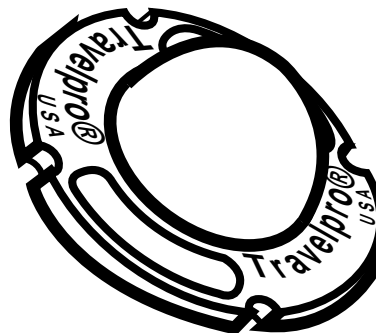

Description: Logo Bumper Foot Side/Bottom
Usage: Rollaboards, Attachables
Part Numbers: P9087
Color Codes: -05 = Charcoal
-14 = Sage

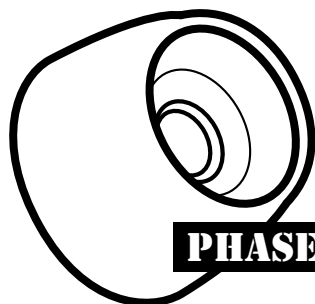

PHASE OUT ITEM

Description: Bumper Foot Side/Bottom
Usage: Rollaboards, Attachables
Part Numbers: P9085
Color Codes: -14 = Sage

PLATINUM II™
Parts Catalog



Component Parts

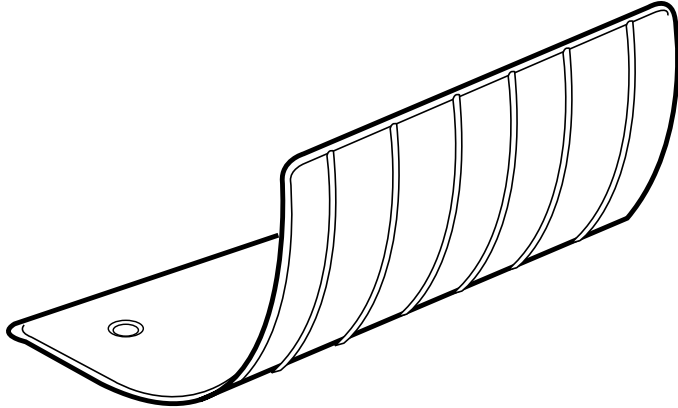

Description: Curved Skid Plate
Usage: All Rolling Items
Part Numbers: P9012 (180mm)
P9013 (140mm)

Color Codes: -05 = Charcoal
-14 = Sage

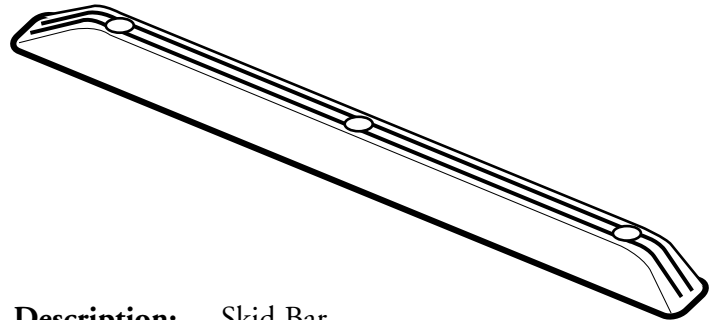

Description: Skid Bar
Usage: Rolling Duffel
Part Numbers: P9014

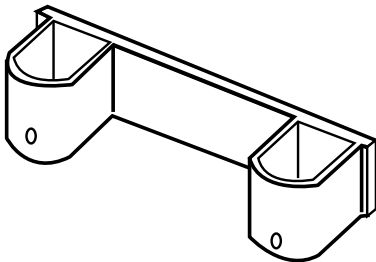

Description: Dual Bottom Bracket
Usage: Rollaboards
Part Numbers: P9091

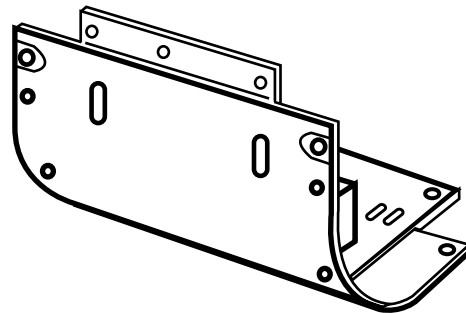

Description: Bottom Bracket
Usage: Rollaboards
Part Numbers: P9020A for 9918
P9020B for 9920S/9923
P9020C for 9924
P9020D for 9926
P9020E for 9929/9934

PLATINUM II™
Parts Catalog



Component Parts

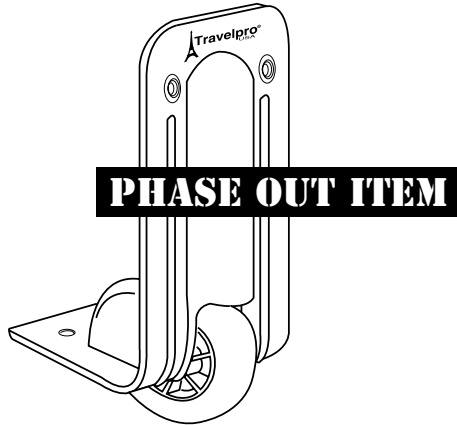

Description: Wheel Housing Assembly
Usage: All Rolling Items
Part Numbers: P9081
Color Codes: -14 = Sage

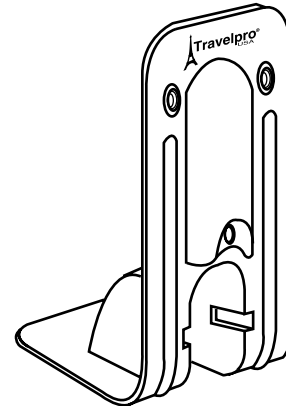

Description: Wheel Housing for Removable Wheel
Usage: All Rolling Items
Part Numbers: P9081A
Color Codes: -05 = Charcoal
-14 = Sage

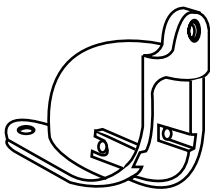

Description: Wheel Housing Insert
Usage: All Rolling Items
Part Numbers: P9081R
Color Codes: -05 = Charcoal
-14 = Sage

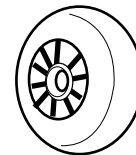

Description: Wheel
Usage: All Rolling Items
Part Numbers: P9081W

PLATINUM II™
Parts Catalog



Component Parts

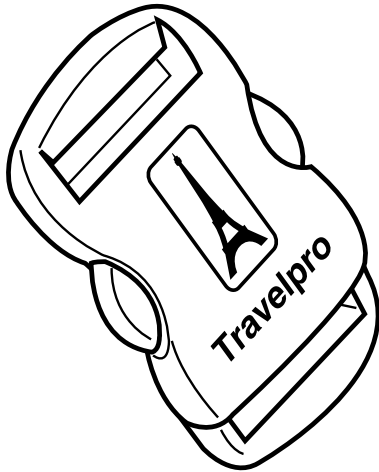

Description: Speed Buckle
Usage: Rollaboards, Attachables
Part Numbers: P9059 (1" Speed Buckle)
P9060 (1½" Speed Buckle)
Color Codes: -05 = Charcoal
-14 = Sage

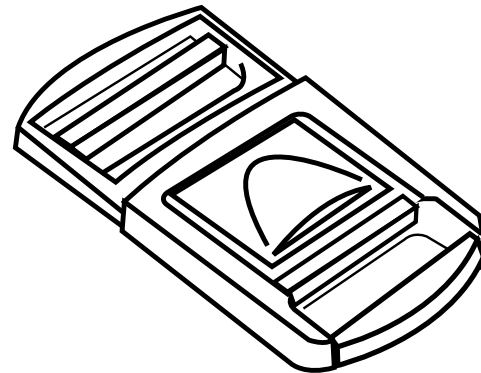

Description: Speed Buckle (Suit Folder)
Usage: Rollaboards
Part Numbers: P9028 (1" Speed Buckle)
Color Codes: -05 = Charcoal
-14 = Sage

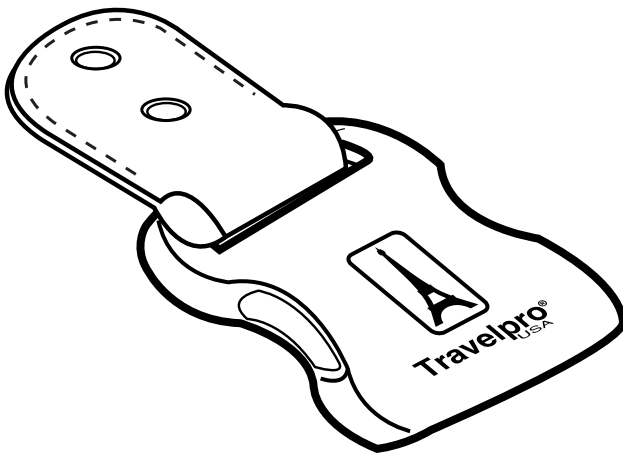

Description: Attachment Buckle with Leather Strap
Usage: Rollaboards
Part Numbers: P9088
Color Codes: -05 = Charcoal
-14 = Sage

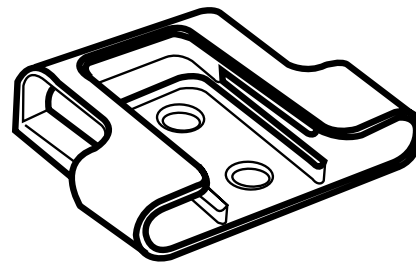

Description: Attachment Clip Base
Usage: All Rolling Items
Part Numbers: P7135
Color Codes: -05 = Charcoal
-14 = Sage

PLATINUM II™ Parts Catalog



Hardware

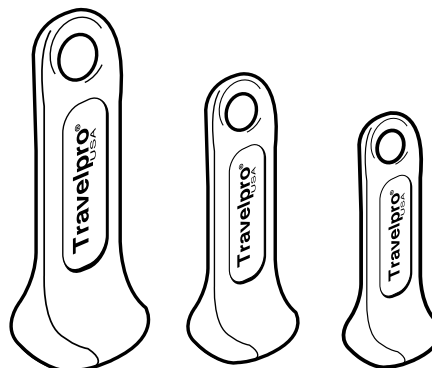
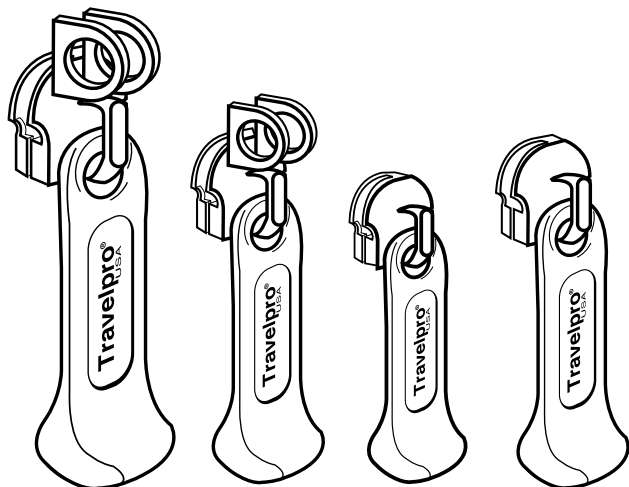

Description: Zipper Sliders with Logo Pulls
Usage: All Products
Part Numbers: P9095 (#10 Locking Slider w/ Logo Pull)
 P9094 (#8 Locking Slider w/ Logo Pull)
 P9093 (#5 Slider w/ Logo Pull)
 P9098 (#8 Slider w/ Logo Pull)

Color Codes: -14 = Satin Silver Plating

Description: Logo Zipper Pulls
Usage: All Products
Part Numbers: P9062 (Zipper Pull, Logo, #10)
 P9063 (Zipper Pull, Logo, #8)
 P9064 (Zipper Pull, Logo, #5)

Color Codes: -14 = Satin Silver Plating

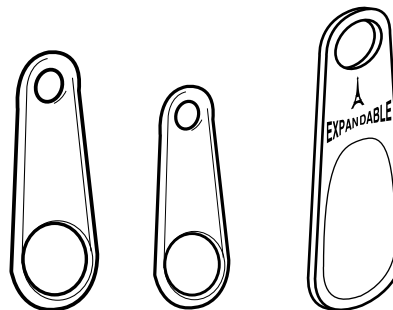
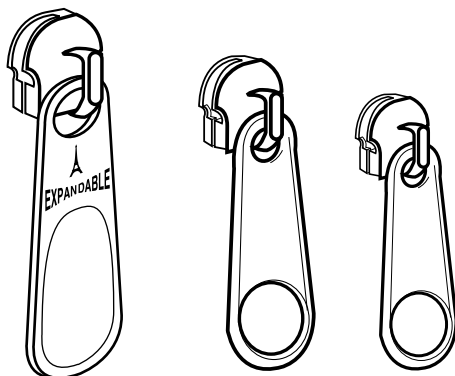

Description: Interior Zipper Sliders with Pull
Usage: All Products
Part Numbers: P9092 (#8 Slider w/ Expandable Pull)
 P9096 (#5 Slider w/ Pull)
 P9097 (#3 Slider w/ Pull)

Color Codes: -14 = Satin Silver Plating
 -05 = Charcoal

Description: Interior Zipper Pulls
Usage: All Products
Part Numbers: P9065 (Zipper Pull, #5)
 P9066 (Zipper Pull, #3)
 P9067 (Zipper Pull, #8 Expandable)

Color Codes: -14 = Satin Silver Plating
 -05 = Charcoal

PLATINUM II™
Parts Catalog



Hardware

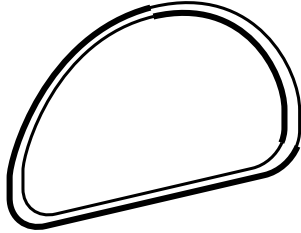

Description: D-Ring
Usage: Garment Bag, Attachables
Part Numbers: P9031 (1")
Color Codes: -14 = Satin Silver Plating

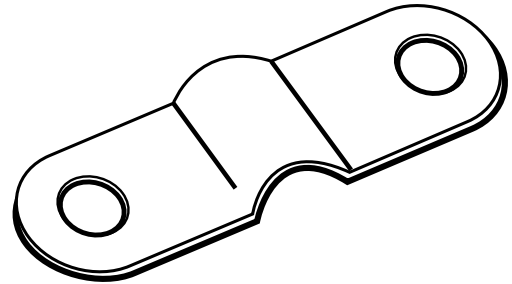

Description: Hanger Brace
Usage: Garment Bags
Part Numbers: P9038
Color Codes: -14 = Satin Silver Plating

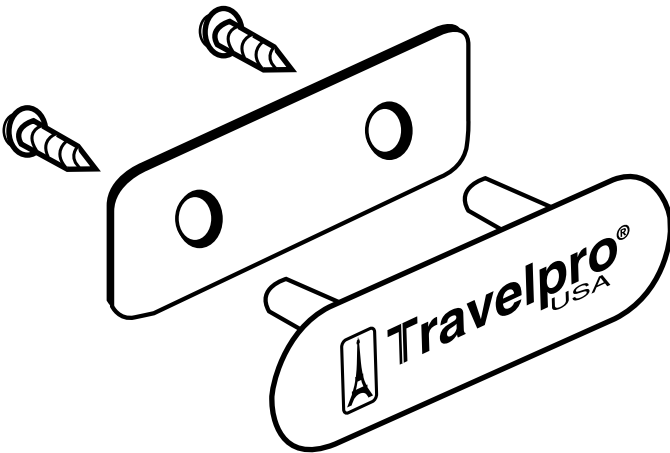

Description: Metal Logo Plate Assembly
Usage: All Products (except 9901A)
Part Numbers: P9024A
Color Codes: -14 = Satin Silver Plating

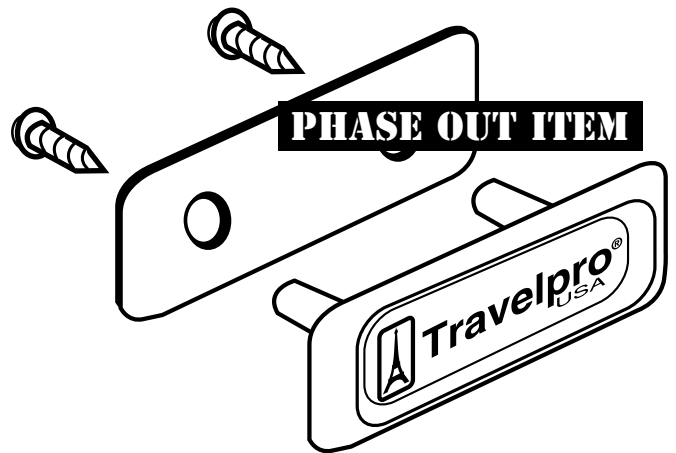

Description: Metal Logo Plate Assembly
Usage: All Products (except 9901)
Part Numbers: P9024
Color Codes: -14 = Satin Silver Plating

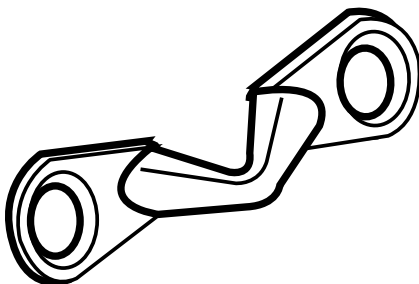

Description: Hanger Brace
Usage: Garment Bags
Part Numbers: P7138

PLATINUM II™
Parts Catalog



Hardware

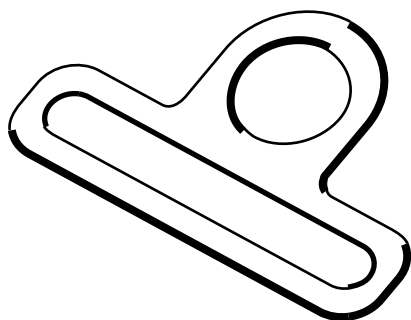

Description: Attachment Ring for P9017

Usage: Attachables

Part Numbers: P9034

Color Codes: -14 = Satin Silver Plating

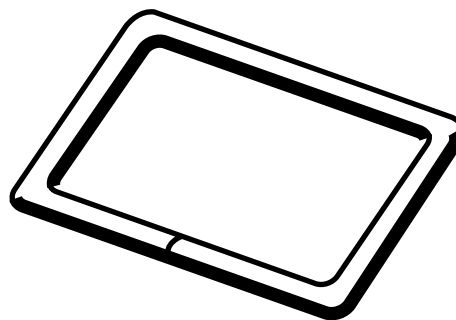

Description: Attachment Clip Ring

Usage: Attachables

Part Numbers: P9036

Color Codes: -14 = Satin Silver Plating

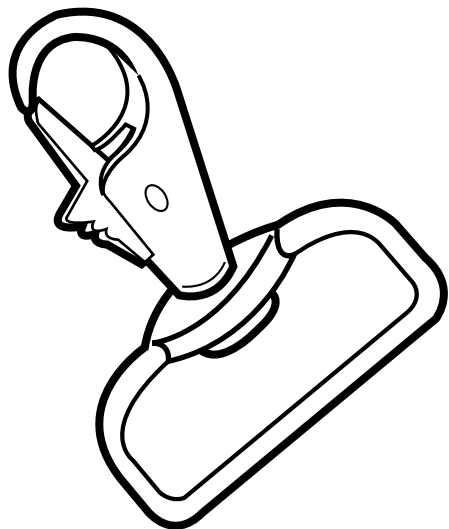

Description: Dog Leash Clip

Usage: Garment Bag Hanger, Shoulder Strap

Part Numbers: P9037 (1")

P9032 (1½")

Color Codes: -14 = Satin Silver Plating

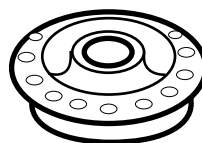

P9040
Snap Cap

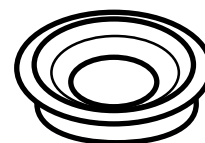

P9039
Snap Stud

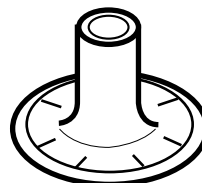

Description: Snap Stud & Snap Cap

Usage: Various Products

Part Numbers: P9039 (Snap Stud)

P9040 (Snap Cap)

Color Codes: -14 = Satin Silver Plating

PLATINUM II™
Parts Catalog



Hardware

Screws, Washer, Nuts, etc.

Part Number	Description	Usage
P9047	Metal Washer, 20mm diameter	Carry handles, retractable handle bezel, wheel housing, foot bar, attachment clip
P9048	Metal Washer, 12mm diameter	Skid plate
P9049	Metal Washer, 11mm diameter	Wheel housing
P9056*	Screw, 18mm	Wheel housing
P9068*	Screw, 25mm, Black Nickel	Carry handles
P9069*	Screw, 30mm, Black	Foot bar
P9070	Machine Nut, Cap Style	Carry handles, retractable handle bezel and bottom bracket, wheel housing, foot bar, attachment clip, skid plate
P9074*	Screw for P9081R	Wheel housing insert screw
P9076*	Screw, 24mm, Black	Attachment clip
P9077*	Screw, 20mm, Black	Retractable handle bottom bracket, skid plate
P9078*	Screw, 16mm	Wheel housing
P9079	Metal Brace	Carry handle (top)
P9080	Axle	Removable wheel
CP9173-1*	Plastic Washer	Carry handles

* = Available in satin silver plating for Sage product. Use color code -14 (i.e., P9056-14)

PLATINUM II™
Parts Catalog



Accessories

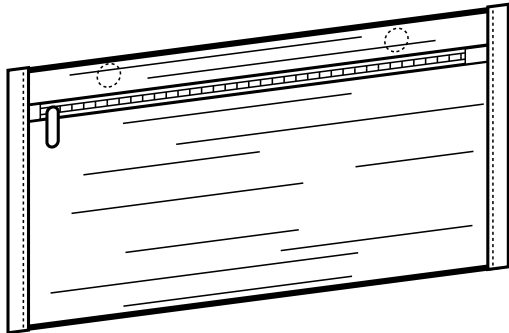

Description: Wet Pocket (16" x 8")
Usage: Rollaboards (26", 29")
Part Numbers: P9072

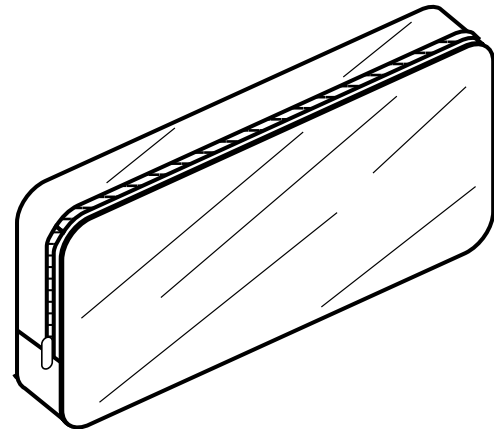

Description: Wet Pocket
Usage: Rollaboards
Part Numbers: P9071A (18"/20"/22"/24")
P9072A (26"/29")

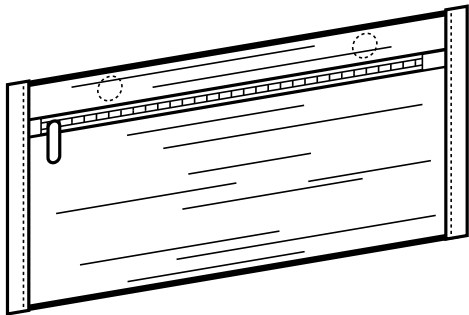

Description: Wet Pocket (13½" x 7")
Usage: Rollaboards (18", 20", 22", 24")
Part Numbers: P9071

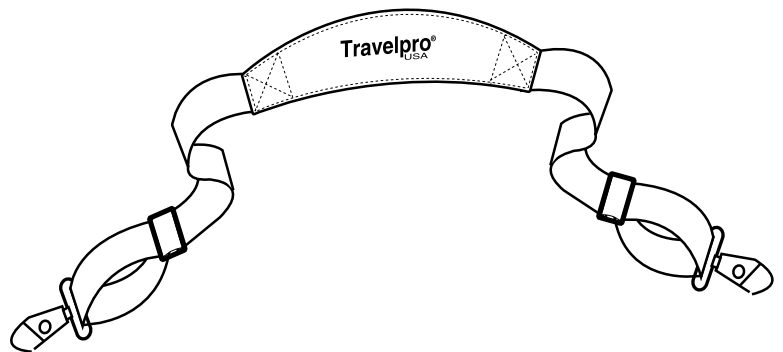

Description: Shoulder Strap
Usage: Attachables
Part Number: P9017

Color Codes: -05 = Charcoal
-14 = Sage

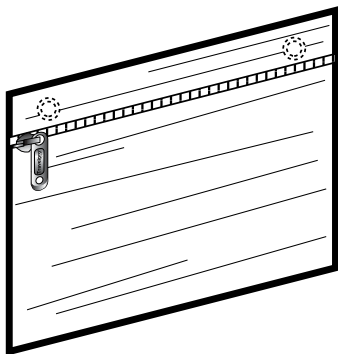

Description: Wet Pocket (8" x 7")
Usage: Deluxe TravelKit™
Part Numbers: P9073

PLATINUM II™
Parts Catalog



Accessories

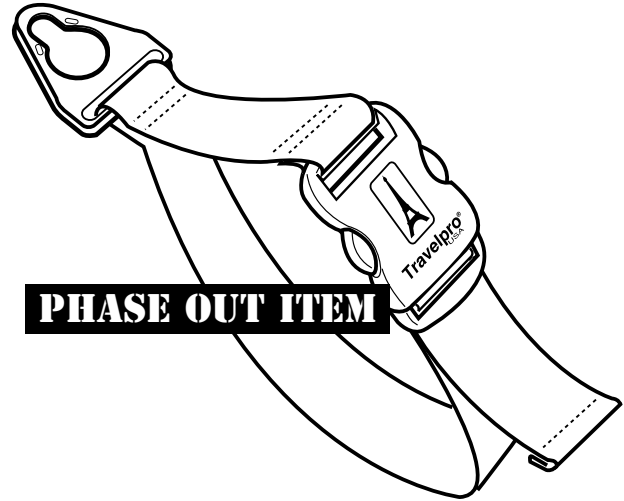

PHASE OUT ITEM

Description: Adjustable Attachment Clip

Usage: Rollaboards

Part Numbers: P9015

Color Codes: -14 = Sage

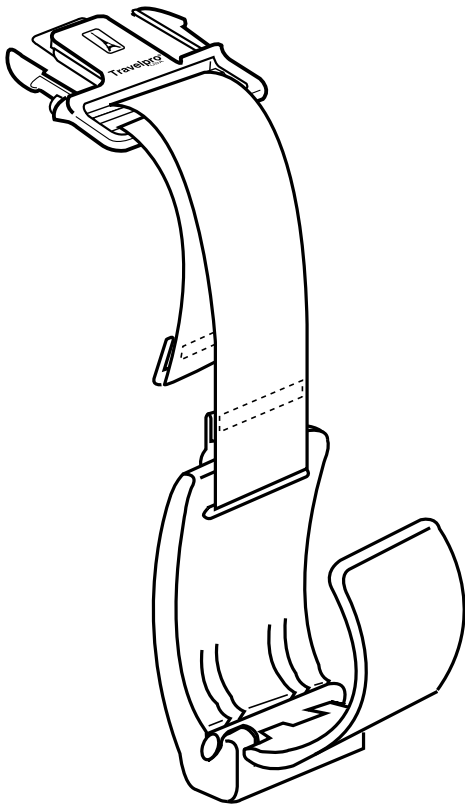

Description: Adjustable Attachment Clip

Usage: Rollaboards

Part Numbers: P7115

Color Codes: -05 = Charcoal

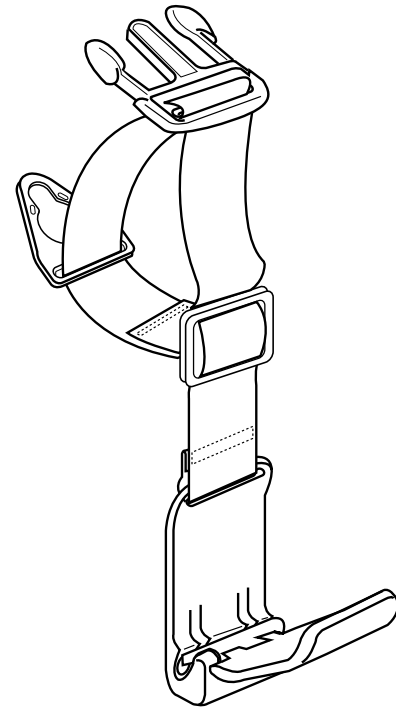

Description: Adjustable Attachment Clip

Usage: Rollaboards

Part Numbers: P7912A

Color Codes: -05 = Charcoal

PLATINUM II™
Parts Catalog



Accessories

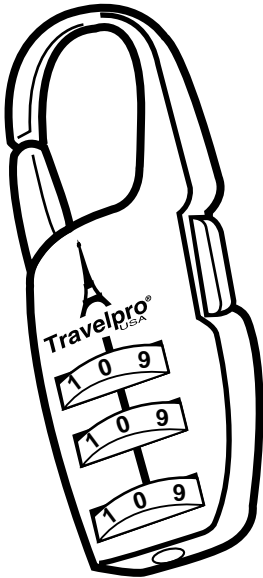

Description: Combination Lock
Usage: Rollboards, Deluxe Garment Bag
Part Numbers: P9061
Color Codes: -14 = Satin Silver Plating

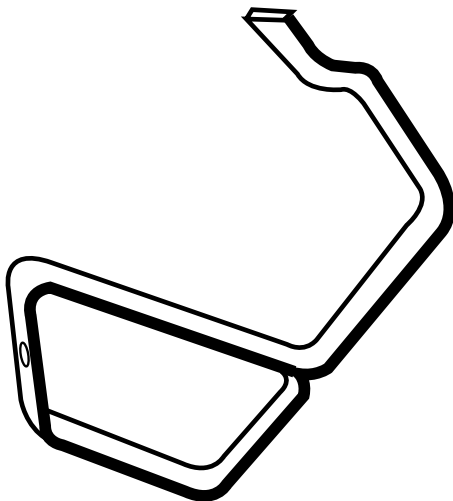

Description: Door Hanger Hook
Usage: Garment Bags
Part Numbers: P9042
Color Codes: -14 = Satin Silver Plating

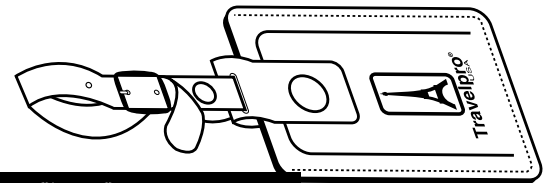

PHASE OUT ITEM

Description: Leather ID Tag Holder
Usage: All Products
Part Numbers: P9016
Color Codes: -05 = Charcoal
-14 = Sage

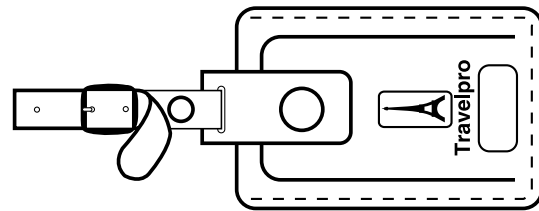

Description: Leather ID Tag Holder
Usage: All Products
Part Numbers: P9016A
Color Codes: -05 = Charcoal
-14 = Sage

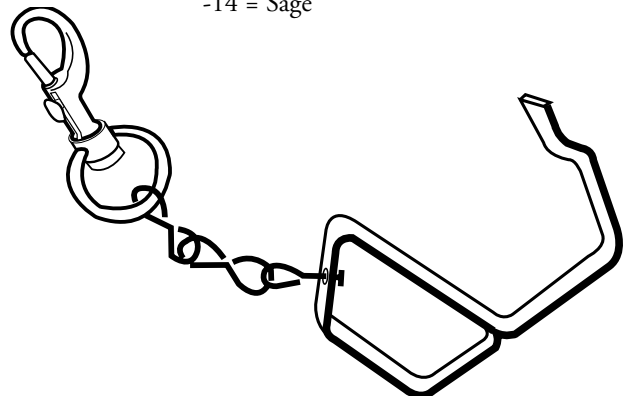

Description: Door Hook with Dog Leash Clip
Usage: Garment Bags
Part Numbers: P9712

PLATINUM II™
Parts Catalog



Accessories

Description: Suit Folder
Usage: Rollaboards
Part Number: P9050B (20" Rollaboard)
P9025B (22"/24" Rollaboards)
P9026B (26"/29" Rollaboards)

Color Codes: -05 = Charcoal

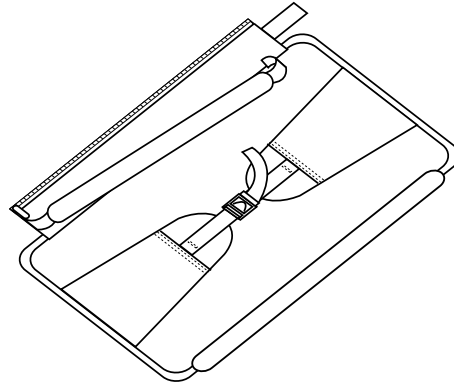

Description: Suit Folder
Usage: Rollaboards
Part Number: P9025 (22"/24" Rollaboard)
P9026 (26"/29" Rollaboards)

Color Codes: -14 = Sage

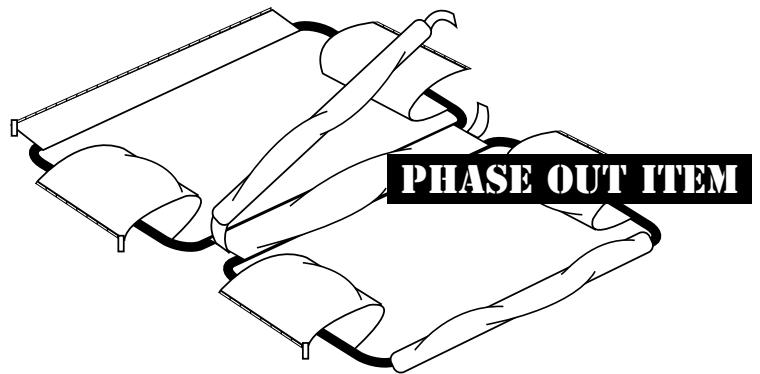

Description: Butterfly Strap Suit Folder
Usage: Rollaboards
Part Number: P9050A (20" Rollaboard)
P9025A (22"/24" Rollaboard)
P9026A (26"/29" Rollaboards)

Color Codes: -14 = Sage

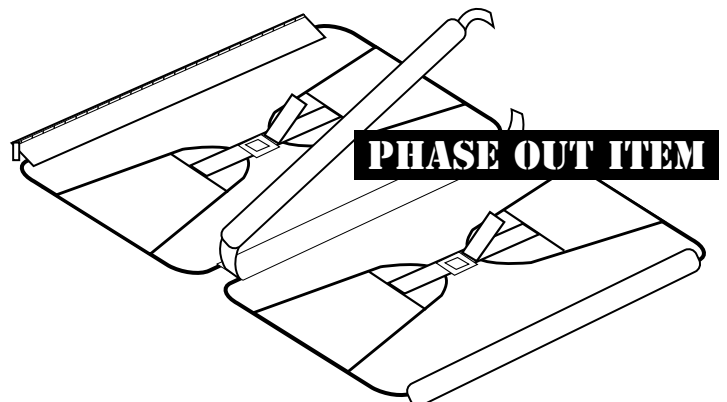

PLATINUM II Parts Catalog



Repair Kits

Each repair kit includes all hardware necessary to replace the part.

Part Number	Description
PK9000A	Retractable Handle, 18" Rollaboard Repair Kit
PK9001A	Retractable Handle, 20" Rollaboard Repair Kit
PK9002A	Retractable Handle, 22" Rollaboard Repair Kit
PK9003A	Retractable Handle, 24" Rollaboard Repair Kit
PK9004A	Retractable Handle, 26" Rollaboard Repair Kit
PK9005A	Retractable Handle, 29" Rollaboard Repair Kit
PK9007A	Retractable Handle, Rolling Garment Bag Repair Kit
PK9008A	Retractable Handle, Rolling Duffel Repair Kit
PK9010A	Carry Handle, (top) Repair Kit
PK9011	Carry Handle, (side) Repair Kit
PK9012	Curved Skid Plate, 180mm Repair Kit
PK9013	Curved Skid Plate, 120mm Repair Kit
PK9081R	Wheel Housing Insert Repair Kit
PK9084A	Bumper Foot Bar Repair Kit
PK9088	Attachment Buckle Repair Kit

PHASE OUT ITEM

Part Number	Description
PK9000	Retractable Handle, 18" Rollaboard Repair Kit
PK9001	Retractable Handle, 20" Rollaboard Repair Kit
PK9002	Retractable Handle, 22" Rollaboard Repair Kit
PK9003	Retractable Handle, 24" Rollaboard Repair Kit
PK9004	Retractable Handle, 26" Rollaboard Repair Kit
PK9005	Retractable Handle, 29" Rollaboard Repair Kit
PK9006	Retractable Handle, 21" BusinessPlus Repair Kit
PK9007	Retractable Handle, Rolling Garment Bag Repair Kit
PK9008	Retractable Handle, Rolling Duffel Repair Kit
PK9010	Carry Handle, (top) Repair Kit
PK9035	Attachment Clip Assembly Repair Kit
PK9081	Wheel Housing Assembly Repair Kit
PK9084	Bumper Foot Bar Repair Kit

PLATINUM II Parts Catalog



✓ mark indicates **PHASE OUT ITEMS**

Item #	Description	Wholesale	Retail
P7115	Adjustable Attachment Clip - Rollaboards	5.00	15.00
P7135	Attachment Clip Base - Rollaboards	0.25	0.50
P7912A	Dual Adjustable Attachment Clip - Rollaboards	5.00	15.00
P7941	Wally Clamp, 2" - Garment Bags	6.50	13.00
P9000 ✓	3-Stage Retractable Handle - 18" Rollaboard	12.50	25.00
P9000A	3-Stage Retractable Handle - 18" Rollaboard	12.50	25.00
P9001 ✓	3-Stage Retractable Handle - 20" Rollaboard	12.50	25.00
P9001A	3-Stage Retractable Handle - 20" Rollaboard	12.50	25.00
P9002 ✓	2-Stage Retractable Handle - 22" Rollaboard	12.50	25.00
P9002A	2-Stage Retractable Handle - 22" Rollaboard	12.50	25.00
P9003 ✓	2-Stage Retractable Handle - 24" Rollaboard	12.50	25.00
P9003A	2-Stage Retractable Handle - 24" Rollaboard	12.50	25.00
P9004 ✓	2-Stage Retractable Handle - 26" Rollaboard	12.50	25.00
P9004A	2-Stage Retractable Handle - 26" Rollaboard	12.50	25.00
P9005 ✓	2-Stage Retractable Handle - 29" Rollaboard	12.50	25.00
P9005A	2-Stage Retractable Handle - 29" Rollaboard	12.50	25.00
P9006	3-Stage Retractable Handle - 21" BusinessPlus	12.50	25.00
P9007 ✓	3-Stage Retractable Handle - Rolling Garment Bag	12.50	25.00
P9007A	3-Stage Retractable Handle - Rolling Garment Bag	12.50	25.00
P9008 ✓	2-Stage Retractable Handle - Rolling Duffel	12.50	25.00
P9009A	3-Stage Retractable Handle - Wardrobe	12.50	25.00
P9010 ✓	Top Carry Handle - All Rolling Items	7.50	15.00
P9010A	Top Carry Handle w/Logo - All Rolling Items	7.50	15.00
P9011	Side Carry Handle - Rollaboards	5.00	10.00
P9012	Curved Skid Plate (180mm) - All Rolling Items	1.25	2.50
P9013	Curved Skid Plate (140mm) - All Rolling Items	1.00	2.00
P9014	Skid Runner - Rolling Duffel	3.50	7.00
P9015 ✓	Adjustable Attachment Clip - Rollaboards	5.00	15.00
P9016 ✓	Leather ID Tag Holder - All Products	4.00	8.00
P9016A	Leather ID Tag Holder - All Products	4.00	8.00
P9017	Shoulder Strap - Attachables	9.00	18.00
P9020A	Bottom Bracket	2.00	4.00
P9020B	Bottom Bracket	2.50	5.00
P9020C	Bottom Bracket	2.75	5.50
P9020D	Bottom Bracket	3.00	6.00
P9020E	Bottom Bracket	3.25	6.50
P9024 ✓	Metal Logo Plate Assembly - All Products (except 9901)	1.00	2.00
P9024A	Metal Logo Plate Assembly - All Products (except 9901)	1.00	2.00
P9025 ✓	Suit Folder (22"/24" Rollaboards)	10.00	20.00
P9025A ✓	Suit Folder (22"/24" Rollaboards)	10.00	20.00
P9025B	Suit Folder (22"/24" Rollaboards)	8.50	17.00
P9026 ✓	Suit Folder (26"/29" Rollaboards)	12.50	25.00
P9026A ✓	Suit Folder (26"/29" Rollaboards)	12.50	25.00

PLATINUM II™ Parts Catalog



Item #	Description	Wholesale	Retail
P9026B	Suit Folder (26"/29" Rollaboards)	9.50	19.00
P9028	Speed Buckle (suit folder)	0.25	0.50
P9031	D-Ring, (1") - Garment Bags	0.25	0.50
P9032	Dog leash Clip (1 1/2") - Garment Bag, Shoulder Strap	1.00	2.00
P9034	Attachment Ring for P9017 - Attachables	0.75	1.50
P9035 ✓	Attachment Clip Assembly - All Rolling Items	0.50	1.00
P9036	Attachment Clip Ring - Attachables	0.25	0.50
P9037	Dog leash Clip (1") - Garment Bag, Shoulder Strap	0.90	1.80
P9038	Hanger Brace - Garment Bags	0.25	0.50
P9039	Snap Stud - Various Products	0.10	0.20
P9040	Snap Cap - Various Products	0.10	0.20
P9041A	Hinged Wally Clamp - Suiters	6.50	13.00
P9042	Door Hanger Hook - Garment Bags	1.25	2.50
P9047	Metal Washer, 20mm Diameter	0.10	0.20
P9048	Metal Washer, 12mm Diameter	0.10	0.20
P9049	Metal Washer, 11mm Diameter	0.10	0.20
P9050A ✓	Suit Folder (20" Rollaboard)	10.00	20.00
P9050B	Suit Folder (20" Rollaboard)	7.50	15.00
P9056	Screw, 18mm	0.10	0.20
P9059	Speed Buckle (1") - Rollaboards, Attachables	0.40	0.80
P9060	Speed Buckle (1 1/2") - Rollaboards, Attachables	0.60	1.20
P9061	Combination Lock - Rollaboards, Deluxe Garment Bag	3.75	7.50
P9062	Logo Zipper Pull (#10) - All Products	0.50	1.00
P9063	Logo Zipper Pull (#8) - All Products	0.40	0.80
P9064	Logo Zipper Pull (#5) - All Products	0.35	0.70
P9065	Interior Zipper Pull (#5) - All Products	0.25	0.50
P9066	Interior Zipper Pull (#3) - All Products	0.20	0.40
P9067	#8 Expandable Zipper Pull - All Products	0.30	0.60
P9068	Screw, 25mm, Black Nickel	0.10	0.20
P9069	Screw, 30mm, Black	0.10	0.20
P9070	Machine Nut, Cap Style	0.10	0.20
P9071	Wet Pocket (13 1/2" x 7") - Rollaboards (18", 20", 22", 24")	2.00	4.00
P9071A	Wet Pocket (13 1/2" x 7") - Rollaboards (18", 20", 22", 24")	4.00	8.00
P9072	Wet Pocket (16" x 8") - Rollaboards (26", 29")	2.50	5.00
P9072A	Wet Pocket (16" x 8") - Rollaboards (26", 29")	6.00	12.00
P9073	Wet Pocket (8" x 7") - Deluxe TravelKit	1.75	3.50
P9074	Screw, for Removable Wheel Insert	0.10	0.20
P9076	Screw, 24mm, Black	0.10	0.20
P9077	Screw, 20mm, Black	0.10	0.20
P9078	Screw, 16mm, Black	0.10	0.20
P9079	Metal Brace	0.25	0.50
P9080	Wheel Axle	5.00	10.00
P9081 ✓	Wheel Housing Assembly - All Rolling Items	5.00	10.00

PLATINUM II™

Parts Catalog



Item #	Description	Wholesale	Retail
P9081A	Wheel Housing Assembly - for removable wheel	5.00	10.00
P9081R	Removable Wheel Insert	5.00	10.00
P9081W	Wheel	5.00	10.00
P9084 ✓	Bumper Foot Bar - Rollaboards, Rolling Garment Bag	1.00	2.00
P9084A	Bumper Foot Bar - Rollaboards, Rolling Garment Bag	1.00	2.00
P9085 ✓	Bumper Foot Side / Bottom - Rollaboards, Attachables	0.25	0.50
P9086	Bumper Foot - Rolling Duffel	0.50	1.00
P9087	Logo Bumper Foot	0.65	1.30
P9088	Attachment Buckle with Leather Strap	0.50	1.00
P9090	Inner Bezel	2.00	4.00
P9091	Dual Bottom Bracket	2.00	4.00
P9092	#8 Slider w/ Expandable Pull - All Products	0.75	1.50
P9093	#5 Slider w/ Logo Pull - All Products	0.75	1.50
P9094	#8 Locking Slider w/ Logo Pull - All Products	0.90	1.80
P9095	#10 Locking Slider w/ Logo Pull - All Products	1.25	2.50
P9096	Interior Zipper Slider w/ Logo Pull (#5)- All Products	0.25	0.50
P9097	Interior Zipper Slider w/ Logo Pull (#3)- All Products	0.20	0.40
P9098	#8 Slider w/ Logo Pull - All Products	0.80	1.60
P9712	Door Hook w/ Dog leash Clip	2.50	5.00
P9800	Towel Bar Hook - Deluxe TravelKit	0.50	1.00
CP9173-1	Plastic Washer- Carry Handles	0.01	0.05
PK9000 ✓	Retractable Handle, 18" Rollaboard Repair Kit	15.00	30.00
PK9000A	Retractable Handle, 18" Rollaboard Repair Kit	15.00	30.00
PK9001 ✓	Retractable Handle, 20" Rollaboard Repair Kit	15.00	30.00
PK9001A	Retractable Handle, 20" Rollaboard Repair Kit	15.00	30.00
PK9002 ✓	Retractable Handle, 22" Rollaboard Repair Kit	15.00	30.00
PK9002A	Retractable Handle, 22" Rollaboard Repair Kit	15.00	30.00
PK9003 ✓	Retractable Handle, 24" Rollaboard Repair Kit	15.00	30.00
PK9003A	Retractable Handle, 24" Rollaboard Repair Kit	15.00	30.00
PK9004 ✓	Retractable Handle, 26" Rollaboard Repair Kit	15.00	30.00
PK9004A	Retractable Handle, 26" Rollaboard Repair Kit	15.00	30.00
PK9005 ✓	Retractable Handle, 29" Rollaboard Repair Kit	15.00	30.00
PK9005A	Retractable Handle, 29" Rollaboard Repair Kit	15.00	30.00
PK9006 ✓	Retractable Handle, 21" BusinessPlus Repair Kit	15.00	30.00
PK9007 ✓	Retractable Handle, Rolling Garment Bag Repair Kit	15.00	30.00
PK9007A	Retractable Handle, Rolling Garment Bag Repair Kit	15.00	30.00
PK9008 ✓	Retractable Handle, Rolling Duffel Repair Kit	15.00	30.00
PK9008A	Retractable Handle, Rolling Duffel Repair Kit	15.00	30.00
PK9010 ✓	Carry Handle, (top) Repair Kit	10.00	20.00
PK9010A	Carry Handle, (top) Repair Kit	10.00	20.00
PK9011	Carry Handle, (side) Repair Kit	7.50	15.00
PK9012	Curved Skid Plate, 180mm Repair Kit	2.50	5.00
PK9013	Curved Skid Plate, 120mm Repair Kit	2.25	4.50